

# Installation Instructions

## Pre-Finished Solid Bamboo

Portfolio Naturals | Synergy MPL | Signature Naturals | Craftsman II | Wright Bamboo



# Industry Designation of Solid Bamboo:

## The customary construction of solid bamboo traditionally describes

1. Flat - Three layers of bamboo strips laminated edge to edge on top of one another. In solid flat grain, the grain of the bamboo layers all run in the same direction.
2. Vertical - Multiple layers of bamboo strips laminated top to bottom and laid on their sides. Exposing the narrow edge of the bamboo strip to the surface of the plank.
3. Strand Woven Bamboo - Multiple layers woven together, and all running in same direction from top to bottom of plank, therefore the behavior of this type of construction most closely resembles the properties of solid hardwood – thus the designation.

## Attention

Before starting installation, read all instructions thoroughly. Should any questions arise, please contact the local Teragren dealer or phone Teragren Bamboo direct at 800-929-6333. Instructions available at [info@teragren.com](mailto:info@teragren.com). All installation instructions must be followed for warranties to be considered valid. Pre-inspect the job site prior to delivery of the floor to ensure the structure is suitable for hardwood flooring installation using the following guidelines.

## Owner/Installer Responsibility

1. Inspect all materials carefully prior to installation. Warranties do not cover materials with visible defects once they are installed. Installation constitutes acceptance.
2. Inspect the bamboo flooring in *well lighted conditions* to ensure proper identification of any potential problems. Carefully inspect the flooring for grade, (see Teragren Bamboo grading standards at [www.teragren.com](http://www.teragren.com)) for color, finish, and quality. If the flooring is not acceptable, contact your Teragren retailer and arrange shipment of replacement material. Defective product will be replaced. Material that is subjectively viewed as unacceptable but falls within Teragren's grading norms will not be replaced.
3. Prior to installation of any flooring, the installer must ensure the job site and subfloor conditions meet the requirements specified in these instructions.

4. Bamboo flooring installation should be one of the last items completed on the construction project. Limit foot traffic on the finished bamboo floor.

## Grading Standards

### General Rules:

Bamboo flooring shall be tongue and grooved and end matched, unless otherwise indicated, as Välinge Self Locking. Flooring shall not be considered of standard grade unless properly dried. The drying standard for Teragren Bamboo solid bamboo product shall be 7 to 9% moisture content by volume with a plus or minus factor of 2% for storage conditions in various climate zones.

### Grading Rules:

Teragren Bamboo floors are not graded in the same way as hardwood flooring. Bamboo has many similarities to wood but different grading standards are applied.

The main stem of a bamboo is called a culm. The culm is the support structure for the branches and leaves, and contains the main vascular system for the transport of water, nutrients and food. Culms also serve as food storage organs. The culm is made up of jointed segments, the joints are defined as nodes by the bamboo industry.

Teragren uses Moso Optimum 5.5 bamboo for the manufacture of its products. We only use the choicest section at the bottom of the culm and segment the raw material into slats or further process into strands. Teragren only harvests the culms when they reach full maturity and hardness. Culms can reach their full size and height in one year, but do not fully mature to their most stable and hardness potential until they are at the peak of age at between 5 ½ and 6 years of age.

The nodes appear randomly throughout the plank, much like small closed knot's would in a wood floor. This is a natural characteristic of the plank.

Flat Grain Slats: Show the most amount of visible nodes.

Vertical Grain Slats: Expose the sides of the bamboo strips and show less of the nodes.

Strand Woven: The strands are created from slats that are randomly split into narrower slats and then woven through each other. The nodes that appear are more random.

*NOTE: The appearance of nodes is an inherent natural characteristic of the product, and not considered to be a manufacturing defect.*

Teragren grading rules allow for filled holes, mineral streak, open checks, tight checks, and filled checks. Bird peck, pin worm hole, and beetle hole are acceptable (any insects are killed with Borate solution and in the drying process).

## Environmental Issues

Damage caused by inappropriate handling, environment, installation, or maintenance issues will not be considered in relationship to grade.

## Storage and Handling

Handle and unload bamboo flooring with care. Store in a dry place, make sure to provide at least a four-inch space using dry 4" x 4" stackers or a dry pallet that provides enough clearance under boxes for proper air movement. Do not stack Teragren boxes directly on the subfloor when storing on job site or during acclimation process.

Prior to delivery of bamboo flooring, outside doors and windows must be in place. All concrete, masonry, plastering, and other "wet" work must be complete and thoroughly dry prior to flooring installation. Roofing and the exterior shell of the structure must be finished and weather tight with doors and windows installed. The wall coverings should be in place and all painting completed—except for the final coat on the base molding. Room temperature and humidity should be consistent with year round conditions for at least one week prior to installation. When possible, install base molding after floor installation is complete.

HVAC MUST BE RUNNING WITH A ROOM TEMPERATURE OF BETWEEN 60°F TO 80°F AND RELATIVE HUMIDITY OF BETWEEN 35 AND 55%, maintained and constant during installation process and throughout life of the floor.

## Pre-Installation Inspection

### VISUAL INSPECTION

The first inspection is visual and basic. Is there water in the building? Are the doors and windows installed and the building weather tight?

### CLIMATE CONTROL

If heating and/or air conditioning with proper humidity controls are in operating condition, they need to be turned on. If it is not possible for the permanent system to operate, a temporary system that provides proper temperature and humidity conditions must be in place and remain in place until permanent climate control is operational.

## INSTALL FLOORING LAST

Bamboo floor should be the last trade in the house (before base boards are installed). All concrete, masonry, plastering/drywall, texturing, and painting/ primer coats should be completed beforehand. Covering the floor while wet trades are in the house can lead to moisture condensation on the protective paper. Moisture can pull into the paper or be trapped under the surface of materials used to cover the floor. Paper coverings also allow dents and scratching to occur. Coverings held in place for more than 24 hours by blue tape can damage the floor. The adhesive in tapes contain Phthalates /plasticizers that have the ability to penetrate floor finishes and bond with the finish at the molecular level presenting a risk of pulling/damaging the finish when the tape is removed. Teragren recommends that built in cabinets and built in furniture be installed before installation of the floor. This prevents damage to the flooring, making any potential flooring repairs simpler to perform.

## Exterior Checks

1. Is exterior soil elevation 6" below edge of flashing?
2. Does exterior slope away from foundation at a rate of 6" drop in 10' for soft landscaped areas and 3" drop in 10' for hard-paved areas?

*NOTE: Proper drainage away from the structure is absolutely critical to ensure weather-tight conditions and crucial to proper hardwood flooring performance. If structure is near a hill, the lot should be graded with a swale to move moisture off the lot and prevent it from coming in contact with the foundation.*

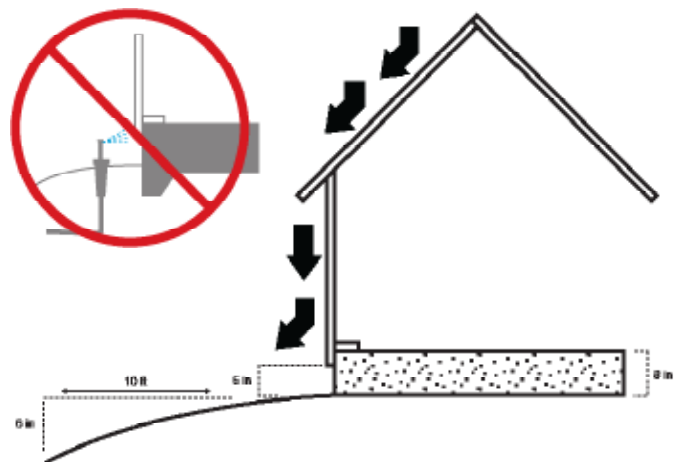

## Crawl Space Ventilation

Crawl space earth (or thin concrete slab) should be covered 100% by a vapor retarder of black polyethylene (minimum 6 mil) or any recommended puncture resistant membrane, such as Class C meeting ASTM D1745. Check local codes for any additional requirements. Size of available vents should equal to 1.5% of the square footage within the crawl space. Relative humidity should be consistent with interior of home. Moisture content of subfloor should not vary more than a 2% MC from the top of the subfloor to the bottom.

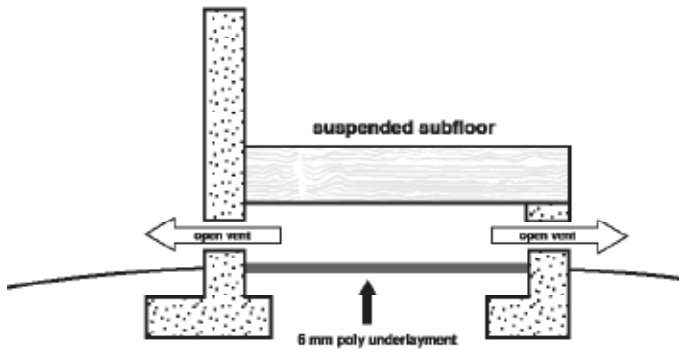

100It may be necessary to install temperature/humidity activated exhaust fans to create more air movement in the crawl space. Uncontrolled humidity and moisture in crawl space will lead to mold and damage to the structure, as well as the bamboo floor. In these events, a contractor specializing in dehumidifying systems will need to be contracted to keep crawl space humidity within proper norms. This is more likely in high humidity areas. Ensure that clothes dryers are properly vented to the outside of the foundation. Check for signs of plumbing, both pressurized and non-pressurized/drain leaks.



*NOTE: Completely sealed crawl spaces (no exterior cross-ventilation) require a dehumidification system as part of the sealed crawl space design.*

## Basement Moisture & Humidity Control

Basements should be completely weather tight and have proper drainage away from the foundation walls in place to ensure that the basement remains dry.

1. Rain gutters must be in place to carry moisture away from the house. French drains are recommended, and basement walls should be properly sealed.
2. Relative humidity of basements should not be more than 10% higher than the upper floors.
3. Humidity control of the basement is vital to help control mold and prevent damage to the structure and bamboo flooring.
4. Basement walls should be inspected for cracks and excessive moisture content.
5. Drains must be placed at basement windows.
6. Direct sprinklers and irrigation systems away from the foundation. Sprinklers spraying the foundation edge can lead to moisture intrusion into structure. Drip irrigation systems for plant beds is recommended.

### EQUILIBRIUM MOISTURE CONTENT (EMC)

The moisture content of Bamboo and Wood fiber saturation point is a function of both relative humidity and temperature in the surrounding air. When Bamboo and Wood is neither gaining nor losing moisture, and equilibrium moisture content (EMC) has been reached.

Wood technologists have graphs that precisely tie EMC and humidity together but as a general rule, a relative humidity of 25% would approximately have an EMC of 5%, and a relative humidity of 75% would have an EMC of approximately 14% EMC.

A 50% swing in relative humidity produces an EMC change of approximately 10%. How that effects Wood and Bamboo flooring varies somewhat by species. However, this change in EMC will create a dimensional change in the material itself. A 5" wide solid plank would change by 1/8" / 25mm per plank. Over a span of 10 boards that would amount to 1 1/4" of expansion.

Teragren manufactures material to mimic what would be found in the middle of a 35–55% relative humidity environment (roughly 40% RH). Consequently, it is pre-acclimated to the green zone conditions found in the chart on page 8.

## Acclimation of Solid Bamboo

The pre-installation inspection of the floor is to be completed prior to the beginning of the acclimation process. Open 2 to 3 boxes to ensure it is what was expected. Test fit the milling and dry lay several planks to ensure the product has no issues. See owner installer responsibility page 1. Do not open all the boxes and subsequently request replacement material.

Solid Bamboo, just like wood flooring, is harvested from a living plant. They are both cellulose based materials and hygroscopic in their structure. As a living plant, the cell walls expand when exposed to moisture to store additional moisture, and the cell wall would conversely shrink when moisture in the cell dropped. This is a well defined biomechanical reaction to changes in relative humidity and corresponding EMC. This is why both wood and bamboo expand and contract with changes in the environmental relative humidity, or exposure to moisture.

**1. Determine Normal Climate Conditions:** Normal interior climate conditions vary among different geographical regions, and job sites vary for numerous reasons as well. Determination of what environmental conditions should exist during acclimation period is the responsibility of the installation professional.

**2. Control Climate Conditions at Time of Acclimation:** Acclimation should occur in normal living conditions at the middle of the normal relative humidity swing for the area. In areas where relative humidity falls below 35%, humidity control must be added to HVAC /Climate Control Systems, to prevent floor from becoming too dry.

**3. Time Required for Acclimation:** The amount of time required greatly depends on proper control of the indoor environment (temperature and humidity). For regions where the relative humidity is at the lower or higher range, more time will be required. The real equation is how much acclimation vs. how long. However, Teragren Bamboo recommends that the flooring material should be acclimated for a minimum of 5 days in a properly controlled environment (average acclimation time 3 to 7 days).

Strand Woven Bamboo can require much more time to acclimate in extreme climate conditions, as much as 30 days may be required.

Humidity ranges and EMC vary geographically. Understanding the average conditions for your region is critical to the acclimation process. If an acclimated EMC is too low, the installed floor will over expand as the relative humidity goes up. If the acclimated EMC is too high the floor boards will gap excessively as the

relative humidity drops later on. (See page 8)  
Reminder: Time is only  $\frac{1}{2}$  the equation. Additional time may be required for acclimation where conditions are not well controlled.

**4. Cross Stack Planks:** For optimum acclimation and stability, Teragren Bamboo requires the cross-stacking of planks in the structure where it is being installed. Stacking on a 4" high pallet, or 4" x 4" stickers, will allow air circulation full access to all the planks. Stack and gap the planks evenly for optimum air flow and uniform acclimation of the planks.

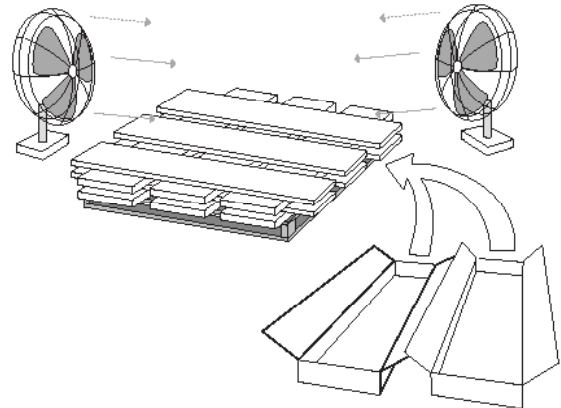

**5. Air Flow:** The use of oscillating fans can aid in air movement assist in moving the air around the material. Point fans away from stack to pull air.

**6. Ideal Room Location for Acclimation:** Place cross stacked material as close to the center of the total installation area as possible. Do not store or acclimate material against exterior wall. Avoid direct sunlight, and keep away from HVAC vents, or in a home without climate and humidity controlled conditions. Garages, covered porches/patios, and non climate controlled basements are not suitable places for acclimation of material

*NOTE: A certain amount of humidity swing is considered to be normal and some tightness and gapping can occur in normal use.*

To maintain proper relative humidity levels, above 35% and below 55% RH, use of the following equipment is recommended. Failure to maintain humidity range can result in damage to the bamboo floor.

Air conditioner (of proper size and in working order )  
Dehumidifier (if required) to prevent relative humidity levels above 55%. Whole House Humidifier of proper size and in working order (if required) to maintain relative humidity levels above 35%.

Acclimation of flooring should continue until the flooring content of the bamboo varies no less than 2% plus or minus, from the subfloor EMC.

*NOTE: Failure to properly acclimate bamboo/wood flooring may cause excessive expansion, shrinking, buckling, or splitting. Proper acclimation of the floor is the responsibility of the homeowner/installer.*

## MOISTURE METER CONVERSION FOR TERAGREN XCORA® STRAND WOVEN BAMBOO FLOORING & FOR PUREFORM® TRADITIONAL BAMBOO

**SOLID STRAND:** *Portfolio Naturals, Synergy MPL, Studio, Craftsman II, Signature Naturals, Wright Bamboo*

The following table has been carefully developed to be compatible with Teragren Xcora® strand bamboo flooring. Moisture readings will vary slightly depending on temperature, density, and color. Expect accuracy to be with +/- 1.5 %.

The following meters have been calibrated to strand bamboo. The lab tests used strand bamboo acclimated to 45%RH at 80° F to establish a base line. In this controlled acclimated environment the moisture content of Teragren's Xcora® strand bamboo tested at 8.3% EMC

### Lignomat



Ligno - Scanner SDM - Pin or Pin Less (Setting ¼ Depth)  
 Ligno - DuoTec BW - Pin or Pin Less (Setting ¼ Depth)  
 Ligno - VersaTec - Pin or Pin Less (Setting ¼ Depth)  
 Bamboo Standard Settings

- 16 Vertical Grain Natural
- 17 Vertical Grain Caramelized
- 18 Horizontal/Flat Grain Natural
- 19 Horizontal/Flat Grain Caramelized
- 20 Synergy Strand Natural
- 21 Synergy Strand Java & Chestnut

### Wagner



MMC205 Digital Shopline - Pin Less

MMC210 Digital Proline - Pin Less

MMC220 Extended Range - Pin Less

- 0.66 Vertical Grain Natural
- 0.67 Vertical Grain Caramelized
- 0.69 Horizontal/Flat Grain Natural
- 0.70 Horizontal/Flat Grain Caramelized
- 0.97 Synergy Strand Natural
- 1.0 Synergy Strand Java & Chestnut

### Delmhorst



Delmhorst - Total Check Plus – Pin Less or Pin

Delmhorst – J4 – Pin

Delmhorst – BD2100 – Pin Delmhorst – J200 - Pin

Delmhorst – 26ES – Attachment Option for Deeper Readings

## Delmhorst Conversion Chart

### Synergy Strand (All)

Meter Reading	Actual %
Douglas Fir Setting	Moisture Content
6	3
7	3.5
8	4
9	4.5
10	5
11	6
12	6.5
13	7
14	7.5
15	8
16	8.5
17	9
18	9.5
19	10
20	11
21	11.5
22	12
23	12.5
24	13
25	13.5
26	14

### Flat Grain/Vertical Grain (All)

Meter Reading	Actual %
Douglas Fir Setting	Moisture Content
6	6.3
7	6.6
8	6.9
9	7.2
10	7.2
11	7.5
12	7.8
13	8.1
14	8.4
15	8.7
16	9.0
17	9.3
18	9.6
19	9.9
20	10.2
21	10.5
22	10.8
23	11.1
24	11.4
25	11.7
26	12.0

## Pin vs. Pin Less – How they work

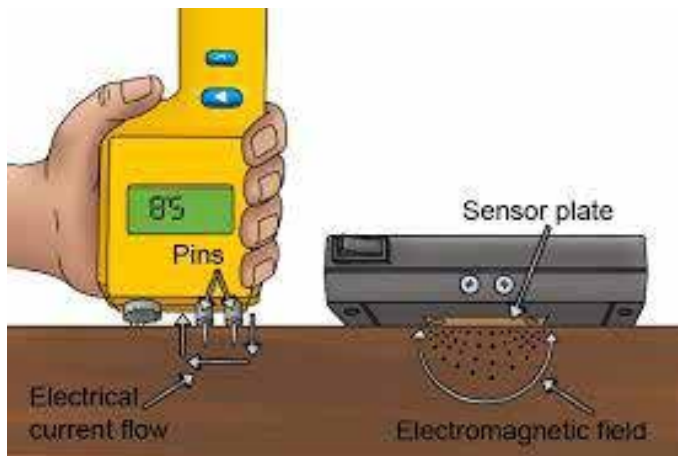

Relative Humidity levels required to maintain below moisture content:

RH		5%	10%	15%	20%	25%	30%	35%	40%	45%	50%	55%	60%	65%	70%	75%	80%	85%	90%	95%	
T	°C																				
30°	-1.1°	1.4	2.6	3.7	4.6	5.5	6.3	7.1	7.9	8.7	9.5	10.4	11.3	12.4	13.5	14.9	16.5	18.5	21.0	24.3	
40°	4.4°	1.4	2.6	3.7	4.6	5.5	6.3	7.1	7.9	8.7	9.5	10.4	11.3	12.3	13.5	14.9	16.5	18.5	21.0	24.3	
50°	10.0°	1.4	2.6	3.6	4.6	5.5	6.3	7.1	7.9	8.7	9.5	10.3	11.2	12.3	13.4	14.8	16.4	18.4	20.9	24.3	
60°	15.6°	1.3	2.5	3.6	4.6	5.4	6.2	7.0	7.8	8.6	9.4	10.2	11.1	12.1	13.3	14.6	16.2	18.2	20.7	24.1	
70°	21.1°	1.3	2.5	3.5	4.5	5.4	6.2	6.9	7.7	8.5	9.2	10.1	11.0	12.0	13.1	14.4	16.0	17.9	20.5	23.9	
80°	26.7°	1.3	2.4	3.5	4.4	5.3	6.1	6.8	7.6	8.3	9.1	9.9	10.8	11.7	12.9	14.2	15.7	17.7	20.2	23.6	
90°	32.2°	1.2	2.3	3.4	4.3	5.1	5.9	6.7	7.4	8.1	8.9	9.7	10.5	11.5	12.6	13.9	15.4	17.3	19.8	23.3	
100°	37.8°	1.2	2.3	3.3	4.2	5.0	5.8	6.5	7.2	7.9	8.7	9.5	10.3	11.2	12.3	13.6	15.1	17.0	19.5	22.9	
110°	43.3°	1.1	2.2	3.2	4.0	4.8	5.6	6.3	7.0	7.7	8.4	9.2	10.0	11.0	12.0	13.2	14.7	16.6	19.1	22.4	
120°	48.9°	1.1	2.1	3.0	3.9	4.7	5.4	6.1	6.8	7.5	8.2	8.9	9.7	10.6	11.7	12.9	14.4	16.2	18.6	22.0	

Teragren bamboo flooring is factory acclimated to a moisture content of 7-9% which correlates to a relative humidity level of 35-55% at 60 to 80 degrees F

**EMC Further Explained:**

- Structure is maintained at a temperature of 70°F
- Maintained and current relativity is 40%RH
- The combined temperature of 70°F and 40%RH – Sustained and constant conditions would produce an EMC 7.7%
- This value is represented in the shaded area in the chart.

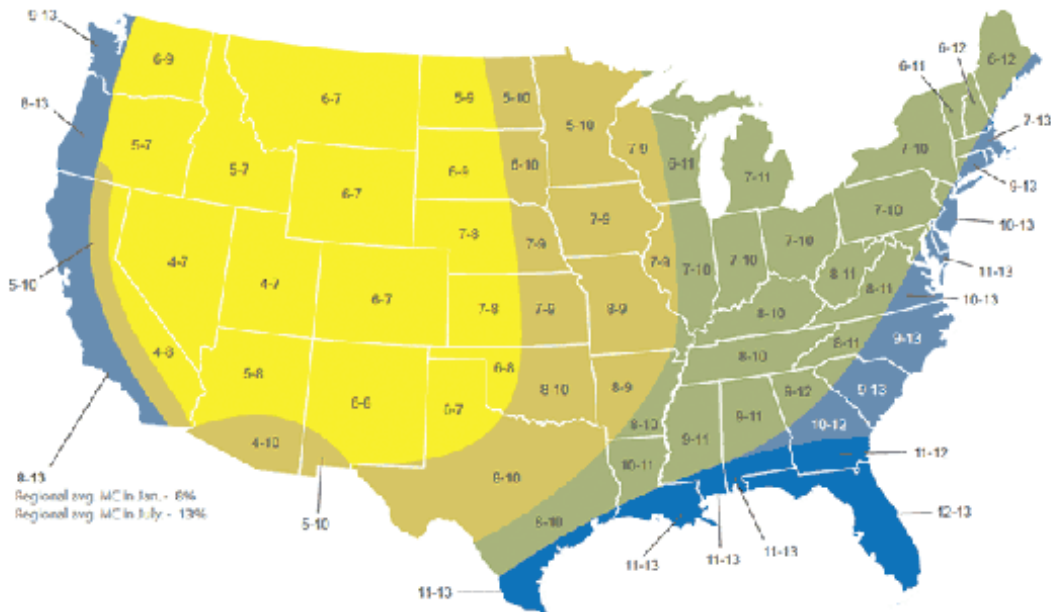

**EMC - Geographic Map of the Continental United States**

NWFA map. Source: The US Department of Agriculture Forest Products Laboratory

Each region has an EMC readings both high and low. This represents a seasonal swing in moisture content.

- Where the EMC readings are below 6.8% humidity, control must be added to maintain structural integrity of floor in the dryer months.
- Humidification systems make heating more efficient and are conducive to enhanced human respiratory health.
- The EMC range per region indicated, pertains to all wood and bamboo species.
- Each region indicates the EMC for both January (the first number) and July (the second number)
- In regions where the moisture content of the material would exceed 10% EMC, HVAC systems must remove some of the humidity for optimum performance. Most air conditioning units dehumidify as part of the cooling process. Additional dehumidification can make the HVAC system more efficient and cost effective to run.

*NOTE: Actual EMC may differ significantly from the numbers indicated on the geographic map. The NWFA indicates that the map cannot be used as a basis for installation. However, it is made available so differences in EMC and the effects of EMC change can be better understood.*



## Radiant Heat

Subfloor level tolerances listed in this publication also apply to radiant heated subfloors.

ELECTRIC RADIANT HEAT SYSTEMS ARE NOT APPROPRIATE FOR TERAGREN BAMBOO FLOORS.

NAIL DOWN TO WOOD SUBFLOOR WITH RADIANT COMPONENTS IS NOT AN AUTHORIZED INSTALLATION METHOD.

PASSIVE RADIANT HEAT SYSTEMS ARE NOT SUITABLE FOR THE INSTALLATION OF TERAGREN BAMBOO FLOORS. PASSIVE SYSTEMS DO NOT HAVE THE ABILITY TO MOVE THE AIR OR CONTROL HUMIDITY LEVELS.

*CAUTION: Surface temperature of the bamboo floor should never exceed 80° F. Temperature sensors must be integrated into system as a fail-safe to prevent excessive heat and damage to the hardwood floor.*

*NOTE: Area rugs placed over radiant heat slab will create heat retention in the floor. This may result in that area exceeding optimum temperature, and causing slightly larger gaps and minor cracks/splits in the floor under the rugs.*

## FLOATING INSTALLATION / RADIANT HEAT

Teragren Bamboo recommends Eternity Premium Underlayment pad or comparable pad. The tongue and groove must be glued together using White PVA-D3 (polyvinyl acetate) tongue and groove adhesive.

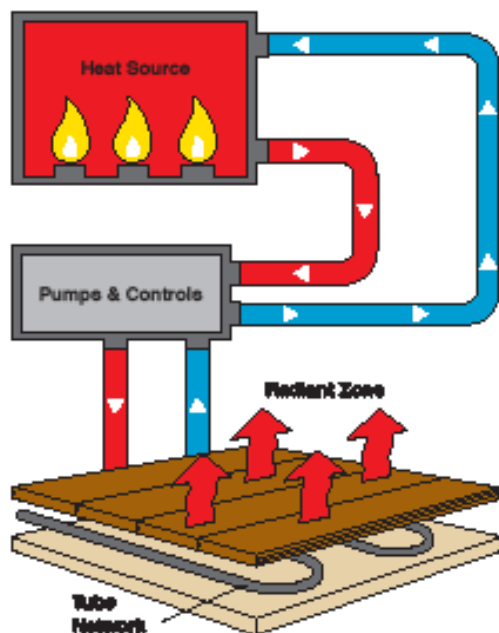

This diagram is a conceptual diagram of the basics of how radiant heat works. It is not a working diagram for installation purposes.

## GLUE DOWN CONCRETE THERMAL MATS / RADIANT HEAT

Adhesive must be approved by adhesive manufacturer for use with radiant heat. Adhesive system must employ a vapor control component designed to be used in conjunction with the adhesive by the adhesive manufacturer. Thermal mass must be Portland based concrete product and rated at a compressive strength of 2500 psi or greater. Thermal mass with less than 2500 psi compressive strength must use floating installation method unless otherwise specified by adhesive manufacturer. Follow adhesive manufacturer's instructions as their psi ratings may be different. Follow all adhesive manufacturer's installation specifications.

Hydronic warm water systems installed in accordance with NWFA specifications are acceptable. Tubing must be a minimum of 1 1/4" below the surface of the concrete thermal mass (no electric mats systems are acceptable). See *Teragren Bamboo, Radiant Heat Guide* for more information.

## HYDRONIC SYSTEMS IN A WOOD Subfloor

Assembly must include an aluminum transfer sheet to ensure even distribution of heat. Aluminum tube hanging systems must cover the entire distance between the joists on the bottom of the subfloor.

## RADIANT HEAT APPROVED PRODUCTS / NO NAIL DOWN ON RADIANT HEAT

Portfolio Naturals – Glue Down  
Synergy MPL – Glue Down  
Craftsman II – Glue Down  
Signature Collection – Glue Down  
Wright Bamboo - Glue Down

## RADIANT HEAT / WOOD SUBSTRUCTURE AND ALUMINUM THERMAL TRANSFER SHEET

Two weeks prior to arrival of bamboo flooring at job site, the radiant heat system should be gradually brought up to 70° F. Moisture levels allowable in wood subfloor are not to exceed 12%. Once systems have reached optimum conditions, Teragren solid bamboo flooring should be brought to job site, not before.

## WOOD FLOOR ACCLIMATION PROCESS FOR RADIANT HEAT

Teragren Bamboo flooring is dried to a moisture content of approximately 7% -9% moisture content by volume. This is a stable moisture content, and it is important to adjust the indoor climactic conditions to fully support the moisture content found in the boards. A relative humidity rating of 35 to 55% at time of installation is required.

Allow opened boxes of Teragren solid bamboo flooring to stabilize in above environment for a minimum 5 days to allow material to adjust to room environment. Additional acclimation may be necessary to get EMC to match environmental conditions. Room temperature should not vary more than 15° F season to season and relative humidity range between 35% to 55% should be maintained.

For further information, see Teragren Bamboo Radiant Heat Guide.

## Below Grade Installation?

A concrete slab is considered below grade when any part of the slab is below ground level. For example, a basement with a walk out is considered below grade. A house cut into a hill is also considered to be below grade if it isn't properly graded to create a drainage swale on the lot. Below grade slabs are not suitable for installation of solid bamboo.

Solid bamboo can be installed on or above grade.

*Solid bamboo flooring is not suitable for below grade*

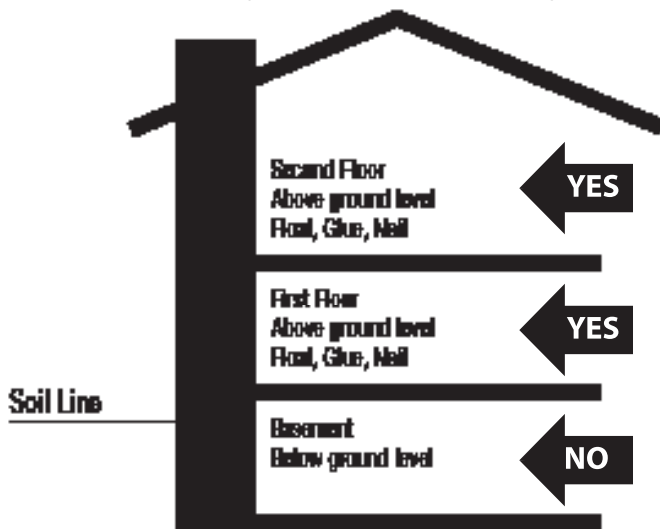

*installation.*

## Subfloor Moisture Testing CONCRETE

Since bamboo flooring is not compatible with wet conditions, Teragren Bamboo does not warrant against moisture related issues or related damage under warranty (See Teragren Bamboo Maintenance & Warranty Guides). This is an industry standard, and manufacturers do not offer moisture warranties. However, moisture warranties are offered by various adhesive manufacturers.

*NOTE: Due to the porous nature of concrete, vapor*

*emissions are subject to change over the lifetime of the installed floor. Slab moisture emissions are a common cause of damage to hardwood and bamboo floors. Due to the potential for concrete moisture emissions to increase/decrease over time, and the absence of moisture warranties for wood and bamboo flooring, choosing an adhesive system that includes moisture abatement properties with a warranty is prudent.*

Adhesive manufacturer's offer moisture warranties for moisture abatement systems that will be conditional. Follow their directions closely to ensure compliance and full warranty coverage. Proper spread rate and coverage are very important. Use proper trowel size and replace trowels at the recommended square footage that the adhesive manufacturer requires to ensure proper application thickness.

Some adhesive manufacturers offer adhesive/moisture abatement systems that do not require pre-installation testing of the slab to maintain a moisture warranty. Check with adhesive manufacturer to confirm which products they offer that allow installation without pre-checking/testing the slab.

*ADDITIONAL NOTE: Teragren Bamboo makes no guarantees regarding the performance of any adhesive/vapor abatement system.*

The installer is fully responsible for proper installation, and the moisture warranties are fully the responsibility of the adhesive moisture abatement system manufacturer chosen for the job.

## NWFA & Industry Standards

The NWFA (Industry standard) uses the following test methods to determine optimal conditions for installation and performance of a hardwood or bamboo floor. Some adhesive manufacturers offer systems that create a vapor barrier to protect the wood or bamboo flooring from moisture emissions coming up through the slab. Many adhesive manufacturers require the tests listed below to be performed prior to installation of the floor. Carefully read and follow the adhesive manufacturer's instructions.

**CALCIUM CHLORIDE: ASTM F1869**

Under ideal conditions, the slab should not be emitting more than 3 lbs. per 1,000 square feet per 24 hour period. Carefully follow the instructions in the test kit to ensure that you get accurate results.

*NOTE: The slab emissions can vary based on soil humidity and room temperature. Consult adhesive manufacturer's directions for the moisture abatement system they recommend.*

**HUMIDITY PROBE & DIGITAL METER: ASTM F2170**  
Widely used in Europe, this test determines the amount of humidity in the slab. This is an effective way to determine a slab's potential for emitting moisture. Follow all meter manufacturer's guidelines for performing testing. Under ideal conditions, the slab readings should be 75% RH. **CAUTION:** Post Tension slabs require special care to avoid cutting cables in slab. Cutting post tension cables can cause serious structural damage and potential fatalities.

New concrete slabs require a minimum of 60 days drying time before covering them with a bamboo floor. The slab must be fully cured. Slab must be comprised of Portland-based mix with 2,500 psi of compressive strength.

## Subfloor Preparation CONCRETE

For glue down application over gypcrete or lightweight concrete, the same 2,500 psi rating is required. (See floating installation section for installation over lightweight substrates).

*NOTE: Some adhesive systems have primers and adhesives that are suitable for use over gypcrete or lightweight concrete, and may have different psi compressive strength requirements. Adhesive manufacturer is responsible for performance of their systems over gypcrete or lightweight concrete.*

Remove all paint, oil, existing adhesives, wax, grease, dirt, sealers, and curing compounds. Do not use solvent-based strippers under any circumstances, as residual solvents can prevent the satisfactory bonding of the vapor barrier and adhesive systems. It is important to ensure a long-lasting bond between the adhesive, the concrete, and the boards.

**FOLLOW ALL ADHESIVE APPLICATION INSTRUCTIONS.** Industry standard practice is to use a sanding system with 20 grit # 3½ open face paper to remove loose, flaky concrete. For heavy surface contamination, it may be necessary to bead blast the concrete surface.

*NOTE: Adhesive manufacturers generally recommend prep fillers and patches to repair concrete substrates that are compatible with the adhesive system to be used. Make sure you use the prep products that are recommended by the adhesive manufacturer.*

Subfloor tolerance for a flat surface is 3/16" within a 10' radius and 1/8" in a 6' radius. These are industry standards established by NWFA. Use a straight edge to

determine if subfloor requires grinding or filling.

*NOTE: A quarter is approximately 1/16" thick and can be used as a basic thickness gauge. Grind high spots and fill low spots with adhesive manufacturer's recommended filler.*

*NOTE: Use the filler recommended by the adhesive manufacturer.*

### **CAUTION: ASBESTOS**

**State and Federal agencies have determined that asbestos is a respiratory carcinogen. Avoid sanding or scraping of old vinyl, linoleum and VCT as they may contain asbestos. Take proper precautions and contact an asbestos abatement company to remove any old vinyl or vinyl tile floors containing asbestos. Cut-back adhesive and other types of adhesives can also contain asbestos.**

## California Prop 65 Warning

Drilling, cutting, and grinding of concrete generates concrete dust, containing crystalline silica, a substance known to the State of California to cause cancer, birth defects, or other reproductive harm. Avoid inhaling concrete dust by wearing a dust mask or other safeguards for personal protection. CA HEALTH AND SAFETY CODE 14808-60-7: Wear appropriate NIOSH designated dust mask to reduce risk of dust inhalation. Wear proper eye protection and avoid prolonged contact with eyes and skin. In the event of eye irritation, flush with water for 15 minutes and seek medical attention!



## Clean the Subfloor

After all prep work is completed, sweep and/or vacuum the subfloor. Dust and dirt can affect the adhesive or vapor barrier's ability to adhere to the slab.

Existing Floor Coverings on Concrete  
Perimeter-glued resilient vinyl, VCT, and rubber tiles, and full spread vinyl are not acceptable substrates and must be removed.

Terrazzo, and porcelain/ceramic tile, that are unbroken

and firmly attached to subfloor can be a suitable as a substrate for a solid glue down installation.

See adhesive manufacturer's instructions for proper vapor abatement properties and installation methods required. *Teragren is not responsible for performance or suitability of existing flooring products that are not removed from concrete.*

As indicated above, the surface must be sound, tight, and free of paint, oil, existing adhesives, wax, grease and dirt.

Terrazzo and ceramic tile must be sufficiently scuffed to assure adhesion. Portland based products must be used to comply with flatness requirements of 3/16" in a 10' radius or 1/8" in a 6' radius. See adhesive manufacturer's guidelines.

Existing vinyl, tile, or terrazzo are not considered to be vapor barriers, and can still transmit unacceptable moisture levels to hardwood flooring. Existing hardwood flooring must be removed prior to the installation of a new wood floor on concrete.

## Subfloor Moisture Testing WOOD

Probe-type (pin) meters are considered the best method of testing. *Remember: the top and bottom of the subfloor should vary no more than 2%. Wood substrates must have a moisture reading of no more than 12% when using Lignomat, Tramax, Delmhorst, or equivalent moisture meter, and be within 4% of the moisture content of the flooring to be installed.*

## Subfloor Preparation WOOD

Wood subfloors need to be well nailed or secured with screws. Nails should be ring shanks, and screws must be counter-sunk. The wood subfloor needs to be structurally sound (i.e. without loose boards, vinyl, or tiles). Subfloor tolerance for a flat surface is 3/16" within a 10' radius and 1/8" in a 6' radius. These are industry standards established by NWFA.

Engineered subfloor panels, must be ANSI-rated plywood, OSB (oriented strand board) of specified thickness to meet joist spacing specifications listed below, or sound solid lumber subfloor that is a minimum of 3/4" thick and dry.

1. For panel products subflooring, check for loose panels and re-nail or screw down loose panels securely. Nails and screws must be countersunk.

2. Ensure that there is proper expansion space (1/8") between the panels. If panels are not tongue and groove and do not have sufficient expansion space, it may be necessary to use a circular saw to create the

specified space. *Do not saw through joints on tongue and groove subfloors.*

3. Check for delamination or damaged areas to subfloor and repair those areas as needed.

4. Make sure subfloor is free of debris before beginning installation.

5. Acceptable Panel Subfloors: Truss/joist spacing will determine the minimum acceptable thickness of the panel subflooring.

- a. Truss/joist spacing of 16" (406cm) o/c or less, the industry standard for single panel subflooring is a minimum of 5/8" (19/32", 15.1mm) CD Exposure 1 plywood subfloor panels or 23/32" OSB Exposure 1 subfloor panels, 4' x 8' panels.

- b. Truss/joist spacing of more than 16", up to 19.2" (488mm) o/c, the standard is a minimum 3/4" (23/32", 18.3mm) tongue and groove CD Exposure 1 Plywood 4' x 8' sheets glued and mechanically fastened.

- c. Truss/joist spacing of more than 19.2" (488mm) o/c up to a maximum of 24" (610mm) requires a minimum 7/8" tongue and groove CD Exposure 1 plywood subfloor panels, 4' x 8' sheets, glued and mechanically fastened, or nominal 1" OSB Exposure 1 subfloor panels glued and mechanically fastened, or two layers of subflooring.

## JOIST CROSS-BRACING

A subfloor that is not thick enough to support the span of the joists will cause unacceptable subfloor deflection. An alternative to adding additional plywood on top of the subfloor would be to cross-brace between the joists. The cross-bracing would be done at the appropriate distance on center to meet specification and bring the deflection within proper tolerance.

Check with the joist or truss manufacturer to determine if cross-bracing is allowed with that system. Should it not be compatible with the joist or truss manufacturer, sheeting the subfloor with a second layer of CD or better grade plywood would then be the only option. (See double layer subfloors section).

## DIRECTION OF INSTALLATION IN RELATION TO JOIST DIRECTION.

The best application is at a 90° angle across the joists.

This provides for best stability of the floor. As an alternative, the floor can be installed at a 45° angle to the joists. The floor cannot be installed in the same direction as the joists without installing an additional

sheet of plywood on top of the existing wood subfloor.

## DOUBLE LAYER SUBFLOORS

When subfloor does not meet thickness standards for span between joists, a second layer of plywood or OSB is required to stiffen subfloor. See item C of previous

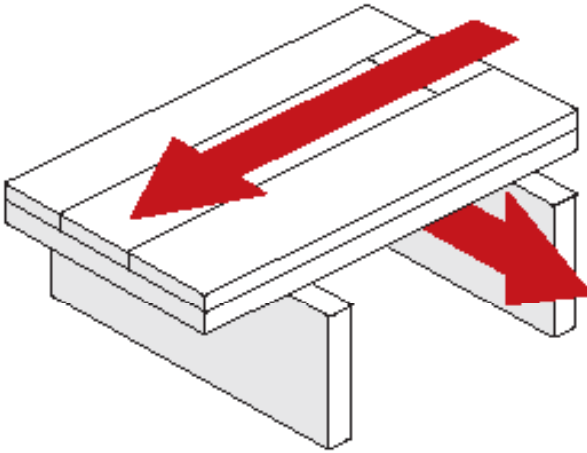

section.

The second layer should consist of nominal ½" (15/32", 11.9mm) CD exposure 1 plywood subfloor panels, 4' x 8' sheets, depending on how much correction of deflection between joists is necessary.

The top layer of plywood should be offset by 2" from joints in first layer of subfloor, and installed in the opposite direction to the bottom subfloor panels. Glue top and bottom layer together with construction adhesive and screwing in to the truss/ joist system every twelve inches. Additionally, nail (ring shank) or staple layers together on a minimum 12" grid pattern.

## EXISTING WOOD FLOOR – ON WOOD SUBFLOOR

When installing over an existing solid hardwood floor already attached to the wood subfloor, ensure that the existing floor is sound and firmly attached to subfloor. Install material at a 90° right angle or 45° angle (across grain) of existing hardwood floor.

*NOTE: Do not install in the same direction as existing floor. Do not install over wood flooring glued to concrete.*

## Getting Started

### 1. Select Installation Type

WOOD SUBFLOOR WITH CRAWL SPACE/ BASEMENT: Glue, Nail, Float

ON/ABOVE-GRADE CONCRETE: Glue, Float

ABOVE GRADE LIGHTWEIGHT CONCRETE GYPCRETE: Float, Glue (see adhesive manufactures installation instructions for lightweight concrete/ gypcrete installations). Teragren solid bamboo flooring is not suitable for below grade installation. See Teragren Engineered Installation Instructions - Synergy Wide Plank or Studio Collections

### RADIANT HEAT: Float, Glue

*NOTE: Floating systems must use good quality underlayment pad with moisture barrier. If using over radiant heat make sure pad manufacturer authorizes their product for radiant installations.*

***Nail down not authorized for Radiant Heat Wood Subfloor Applications. Any wood subfloor that contains radiant tubing of any kind is not appropriate for nail down application!***

## 2. Cabinets & Appliances

NAIL DOWN & GLUE DOWN: Cabinets and built in appliances (sub-zero refrigerators & dishwashers) should be installed prior to the installation of the bamboo floor. Cabinets and built in appliances should not be installed on top of the floor. Installation of cabinets on top of glue or nail down installation does not invalidate warranty. However, since this is not best practice, should the floor require repair under warranty, Hallmark Floors will not be liable for costs to remove and replace cabinets and or counter tops to effect repair.

**FLOATING:** Cabinets and built in appliances should never be installed on top of the floating bamboo floor. Floating floors require unhindered expansion space in all directions.

Bamboo flooring should be installed at the same time as carpet and after the following: finishing walls, cabinet installation, appliance installation, tile & counter top installation.

Standard refrigerators and kitchen oven/range are acceptable for placement on top of the wood floor. Use caution when moving appliances by using a proper furniture dolly, air sled, 1/8" Masonite with glossy side down, or plastic glides designed for movement of heavy appliances. Failure to follow these precautions will damage the floor.

### 3. Undercut All Door Jambs/ Moldings

Remove all shoe and base molding to ensure adequate expansion space. Use scrap piece of flooring to establish height of cut. Make allowances for adhesive or underlayment thickness when establishing height of cut.

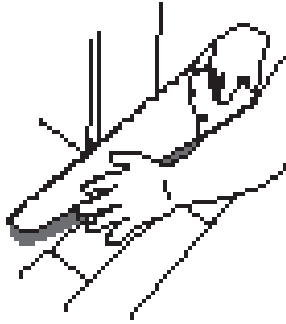

### 4. Visual Inspection of Boards

Visually inspect boards for any defects prior to installation. Verify that homeowner has seen product and approves proceeding with installation of the floor.



### 5. Open Multiple Boxes

Always work from multiple boxes simultaneously and blend the boards throughout the installation. This is especially important with mixed production dates. Teragren Bamboo has very good color consistency, and mixed production dates is generally acceptable for installation. Working from multiple boxes/production dates helps achieve a good blend of color.

*NOTE: As good as color consistency is, still check in the event they are not a good blend with each other. Mix a box from each production run together to determine if mixed dates are acceptable and match each other well. Perform check prior to acclimation.*

### 6. Blend Boards to Moldings

Before you get started, inspect the moldings. At beginning of installation, set aside those boards that best blend to the transition moldings on job.

### 7. Select a Starter Wall

It is recommended to start the installation along an exterior wall. Check to make sure the wall is straight and square to the room.

### 8. Starting Line

Cut blocks to use against side and end walls to maintain 1/2" minimum expansion space. Use of adjustable spacers may be needed to help maintain a straight line.

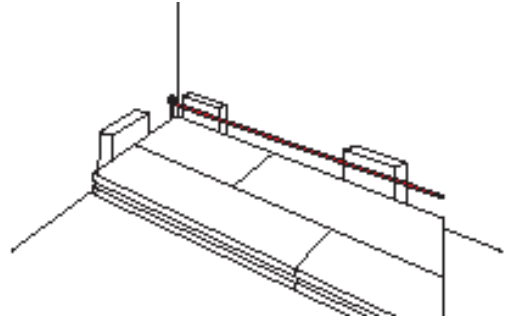

### 9. Irregular & Out-of-Square Walls

Scribe cut the first row to match variations in the wall. A scribe can be created by drilling a hole in a scrap piece of wood and inserting a pencil. The starting row can then be cut to compensate for an irregular wall or to help minimize the appearance of an out of square room by splitting the difference between the two walls.

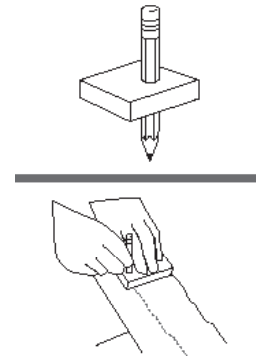

## 10. Establishing End Joint Spacing

Applicable to all three methods of installation (glue down, nail down, float). Each box contains random length boards. Use these boards as well as making some random cuts to establish a random pattern. Maintain a minimum distance/stagger between end joints of 4-8".

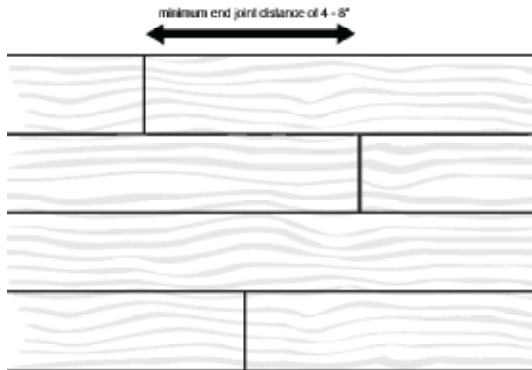

## 11. Change of Direction

GROOVE TO GROOVE, USING A SLIP TONGUE/WOOD SPLINE:

Slip-tongue/wood-spline can be fabricated using birch plywood, cut into strips on a table saw. Cut width to 5/16" wide to allow room for glue once inserted.

The following thickness of Baltic Birch plywood should be used to fabricate wood spline for the following thickness of Teragren Bamboo Flooring:

Synergy MPL – Portfolio  
4mm or 5/32" ripped 8mm wide

Craftsman II – Signature  
5mm or 3/16" ripped 10mm wide

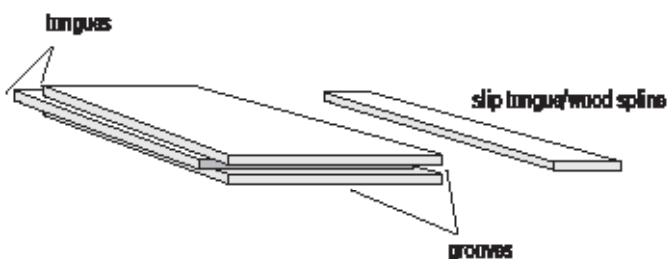

*NOTE: Sand corners of spline with sanding block and 60 grit sandpaper to soften/round the edges (all four sides).*

*Make sure about 0.3 to 0.4mm (about the thickness of a business card) of space is left between spline and the back of the groove, so the spline is not overly tight, and glue has enough room.*

## Installation Alert

Do not use rubber mallets or hammers on the finished edge of the floors. Do not kick the floor into place. Mallets and hammers damage the finished edge and kicking can scratch the floor. Make sure mallet driven gun is not damaging the side of the board.

Use overlapping nylon tapping block for glue down. Use a flush edge nylon tapping block for nail down and for floating installations.

## Glue Down Installation

### GENERAL INFORMATION

*NOTE: Follow previous instructions 1-11 and all directions listed below.*

## Installation Tools GLUE DOWN (GD)

Tape measure, pencil, chalk line, table saw, cut-off saw, jamb saw, tapping block, pull bar, spacers, ratcheting floor straps, hammer, safety glasses, hearing protection, utility knife, specified notched trowel, wall spacers, straight edge, broom, speedy square, hardwood floor cleaner, and shop vacuum.

## 12. GD Remove Tongue & Lead with Groove

Cut off tongue on very first row to be installed and lead with the groove. This enables the tongue to be partially inserted into the groove before coming into contact with the adhesive.

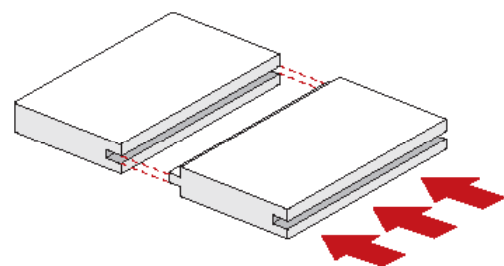
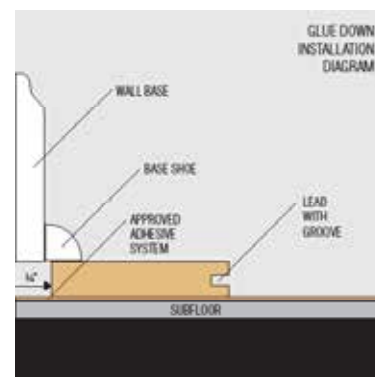

### 13. GD Starter Rows

Measure the equivalent of four to five rows, mark subfloor at both ends of run and snap a chalk line. Spread adhesive to chalk line. Repeat this process on all subsequent rows of material throughout the balance of installation.

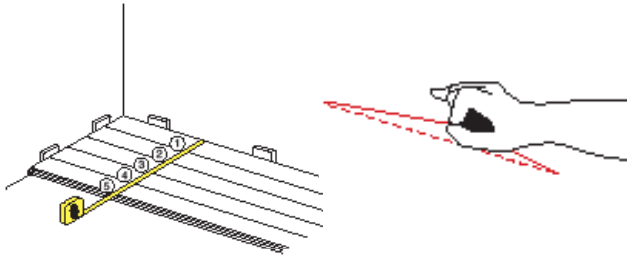

*NOTE: It may be necessary to use painter's tape for delicate surfaces during the install to keep planks together, while glue dries. Remove delicate surface painter's tape within 24 hours of application.*

### 14. GD Rolling Floor

Most adhesive manufactures require a floor to be rolled at specific intervals during installation. Follow all Adhesive manufactures Specifications

*NOTE: To prevent damage to finish, wrap steel rollers with a fresh layer of duct tape for each new job.*



### 15. GD Strap Starter Rows

Once starter rows are installed up to chalk line/edge of adhesive bed, strap across the grain. Allow adhesive to set up long enough to have a firm hold. Use the flat side of the trowel to flatten any adhesive at edge of the leading board. Once the boards are firmly seated, proceed to work across the floor.

*CAUTION: Do not let boards open or drift off straight line.*

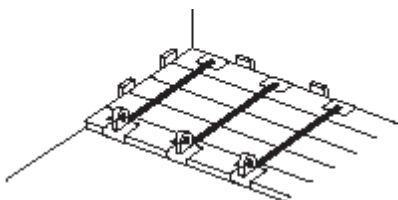

### 16. GD Check Straight Lines

Run string along joint lines to check in you are wandering off line and use caution to keep all end and side joints closed. The edge of a 6' level or straight edge along the leading rows can also help determine the maintenance of a straight line.

### 17. GD Trim & Fit Last Row

Cut the last row, place into adhesive and snug into place using a pull tool.

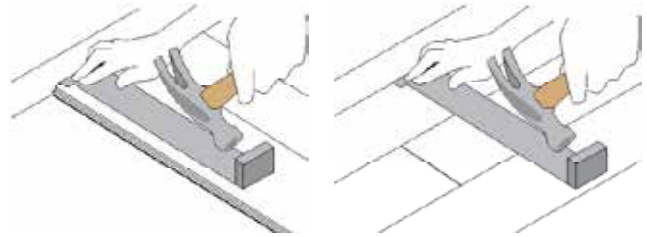

### 18. GD Install Transition Moldings

Install moldings using urethane glue or high-quality adhesive. It may be necessary to place weight on edge to ensure molding level is flush with flooring.

### 19. GD Remove All Adhesive

Remove as installation progresses. Adhesive that is allowed to dry and cure on the finish can damage fuse to the surface finish.



## Nail Down Installation

### GENERAL INFORMATION

*NOTE: Follow instructions 1-11 and all directions listed below.*

### Installation Tools NAIL DOWN (ND)

Tape measure, pencil, chalk line, table saw, cut-off saw, jamb saw, tapping block, pull bar, spacers, hammer, safety glasses, hearing protection, utility knife, wall spacers, straight edge, broom, speedy square,



hardwood floor cleaner, pin/finish nails, air compressor, and shop vacuum.

## GENERAL INFORMATION

*NOTE: Follow instructions 1-11 and all directions listed below.*

*NOTE: Our products are not warranted against squeaking, crackling, popping, or movement in the floor when cleat/nail-down installation is used. Some of these events are natural and going to occur as subfloors settle or dry. These issues may be more noticeable during low or high humidity events.*

## SET UP AND USE OF PNEUMATIC CLEAT-NAILERS

Minor squeaks and pops are normal in nail down installations. This is not considered to be a manufacturing defect and is an accepted fact by the industry and the National Wood Flooring Association. Teragren Bamboo's Maintenance and Warranty Guide does not cover squeaking or popping of floor.

To minimize these issues, make sure that subfloor thickness and joist spacing are correct and the subfloor is sound. Repair any structural issues with subfloor prior to installation of the floor (see page 11).

Make sure your nail/cleat gun is properly adjusted to put the fastener in the pocket (where the back of the tongue and the side of the plank meet). Pay close attention to placement and if any damage is being done to the edge of the plank by the nail gun. Adjust the air pressure up or down until setting seats the cleat into pocket.

- Too little air pressure leads to the cleat sitting too high, allowing excess movement and rubbing against the edges of the plank above the tongue and groove.
- Too much air pressure will seat the cleat too low and distort the tongue of the plank.
- Improper adjustment of gun can lead to the tongue being placed outside of the pocket, potentially breaking the tongue, splitting the veneer line in the core, or leaving a bump at the edge of the plank where the fastener is placed.

Air Pressure Settings

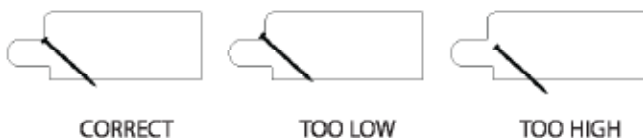

## PROPER CLEAT PLACEMENT

### Approved Nail/Cleat Fastening Systems

Due to the hardness of bamboo flooring, floor stapling systems are not suitable for use when installing Teragren Bamboo. Staples tend to bend and fold up in use, due to hardness of Teragren Bamboo Floors. 18 to 20 gauge cleat systems with an 1 1/2" leg are the only fasteners approved for nail down installation of Teragren Bamboo Floors.

#### POWER NAIL PNEUMATIC MODEL 50P Flex

18 gauge cleat - 1 1/2" leg.

Use 12 oz. rubber hammer to activate gun. Gun adjusts to nail 12mm, 14mm, 15mm. Other versions of Pneumatic Model 50 are also acceptable.

#### POWER NAIL MODEL 50F

18 gauge cleat - 1 1/2" leg. Trigger driven gun adjusts to nail 12mm, 13mm, 14mm.

#### POWER NAIL PNEUMATIC MODEL 200

20 gauge cleat - 1 1/2" leg. Use 12 oz. rubber hammer to activate gun. Gun adjusts to nail 12mm, 14mm, 15mm.

#### PRIMATEC PNEUMATIC MODEL 550A

18 gauge cleat - 1 1/2" leg.

Use 12 oz. rubber hammer to activate gun. Gun adjusts to nail 12mm, 14mm, 15mm.

#### PORTA NAIL PNEUMATIC MODEL 418A

18 gauge cleat - 1 1/2" leg. Use 12 oz. rubber hammer to activate gun. Gun adjusts to nail 12mm, 14mm, 15mm.

Follow all gun manufacturer's guidelines for psi settings. Some adjustment to psi in the field is generally necessary, to ensure cleat seats properly in the pocket. Improper placement of the cleat can compromise the performance of the floor.

## 12. ND Underlayment

### RECOMMENDED UNDERLAYMENTS

15 to 30 lb. roofing felt when doing a nail down installation. Staple in place and then proceed to install the floor.

Aquabar "B" Hardwood Floor & Tile Underlayment Staple in place and then proceed to install the floor.

Allglobe -Silicone Vapor Shield. Staple in place and then proceed to install the floor.

**CAUTION:**

Red Rosin or craft paper is not an accepted underlayment. Foam underlayment pads are not acceptable for nail down. Elimination of underlayment's in favor of running beads of construction adhesive to increase the holding power to the subfloor has some risks. Underlayment's have always acted as a vapor inhibitor. Without the underlayment, the floor is subject to cupping and crowning from moisture intrusion from the subfloor.

### 13. ND Starter Rows

Nail-down method requires that installation be done by leading with the tongue. When starting at the wall, trim groove off the back of the boards being used for the starting row. Face nail the back edge of the board with 18-gauge nails, then blind nail into the pocket above the tongue with one of the above approved nail/staple systems.

As face nailing is accepted practice, face nailing the boards as far back as possible can help hide the face nailing under the base and quarter round/base shoe. It may be necessary to blind nail the tongues of the starter boards to eliminate any surface nail holes until far enough from the wall to use floor nailer.

### 14. ND Nail/Cleat Spacing

Nail/cleat spacing needs to be 4" to 6" apart and within 2" of board ends. Installer should be standing directly on top of the board being nailed down. This ensures the bottom of the plank is firmly seated on the subfloor. Check regularly to ensure the plank is snug to the subfloor. Any gap between the bottom of the plank and the subfloor is a source for squeaking.

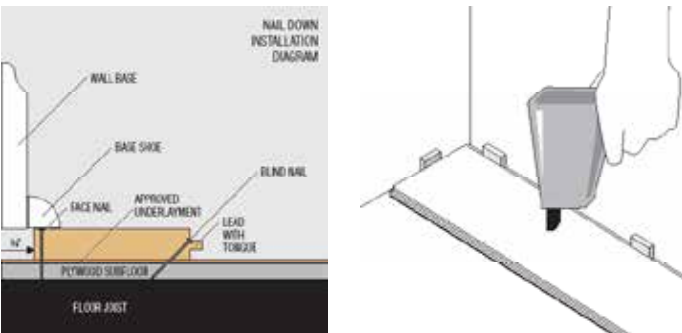

*Warning: Nailing too close to end could fracture the corner of the plank.*

### 15. ND Check Straight Line

After three rows of flooring have been installed, take a six-foot level and check the leading edge to be sure floor is on a straight line. Lay the level on its back and glide bottom edge along the tongue. Failure to stay on a straight line will cause irregular gaps in floor on sides and ends.

## 16. ND Trim & Face Nail End Rows

Cut the last row and snug into place using a pull tool. Face nail the remaining rows with 18 gauge nails. It will be necessary to face nail the remaining rows when the blind nail gun is too close to the wall to fasten down the planks.

## Floating Installation

### GENERAL INFORMATION

### DO NOT FLOAT TONGUE & GROOVE PRODUCTS

A. Clean up any adhesive or glue residue immediately. If glue or adhesive is allowed to dry on the floor's surface, it can damage the finish when it is removed.

B. Completely remove any delicate surfaces painter's tape (never use masking tape) within 24 hours of application. If direct sunlight is hitting tape, it must be removed within 12 hours.

C. Adhesive residue, glue residue, and shoe marks can be removed with mineral spirits. NuOil®: Follow immediately with NuOil® Natural Oil Cleaner to remove any mineral spirit residue. TrueMark Poly/Glaze Tek® Finish: Follow immediately with TrueClean® Floor Cleaner to remove mineral spirit residue.

D. Remove dust and dirt regularly during installation and upon completion with a soft brush attachment on a shop vacuum.

E. Move refrigerators with a soft wheel dolly or glides to avoid denting floor. Do not install stiff copper tubing from water source to ice maker. Use flexible braid tubing instead. A braided hose is much more durable and less prone to leak.

*For flooring touch up and scratch repair, refer to Teragren website at [www.teragren.com](http://www.teragren.com)*

# Coordinating Accessories

Stair Nosing



T-mold



Floating Floor Reducer

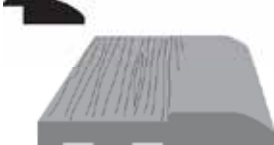

Clamshell Reducer



Baby Threshold



Stair Nosing - Floating Floors





FINE BAMBOO FLOORING, PANELS & VENEER